

Instruction and Operation Manual

S110-P-V2

Power and Energy Meter



Dear Customer,

Thank you for choosing our product.

The operating instructions must be read in full and carefully observed before starting up the device. The manufacturer cannot be held liable for any damage which occurs as a result of non-observance or non-compliance with this manual.

Should the device be tampered with in any manner other than a procedure which is described and specified in the manual, the warranty is cancelled and the manufacturer is exempt from liability.

The device is destined exclusively for the described application.

SUTO offers no guarantee for the suitability for any other purpose. SUTO is also not liable for consequential damage resulting from the delivery, capability or use of this device.

Revision: 2024-1



Last modifications: May, 2024

Table of contents

1	Safety instructions.....	4
2	Registered trademarks.....	5
3	Application.....	6
4	Features.....	6
5	Technical data.....	6
5.1	General.....	6
5.2	Electrical data.....	7
5.3	Input-signals.....	7
5.4	Accuracy	7
6	Dimensional drawing (in mm).....	8
7	Installation	9
7.1	Voltage and current connection.....	9
7.1.1	3-phase / 4-wire connection.....	9
7.1.2	3-phase / 3-wire connection.....	10
7.1.3	1-phase / 2-wire connection.....	10
7.2	Electrical connection.....	11
7.2.1	Connection to S551	11
7.2.2	Connection to the Rogowski coils.....	13
7.2.3	Connection to the Voltage leads.....	14
8	Optional extra accessories.....	15
8.1	Extra accessories for S110-P.....	15
9	Maintenance.....	15
10	Disposal or waste.....	15

1 Safety instructions

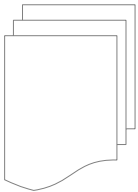

Please check if this instruction manual accords to the product type.

Please observe all notes and instructions indicated in this manual. It contains essential information which have to be observed before and during installation, operation and maintenance. Therefore this instruction manual has to be read carefully by the technician as well as by the responsible user / qualified personnel.

This instruction manual has to be available at the operation site of the power meter at any time. In case of any obscurities or questions, regarding this manual or the product, please contact the manufacturer.



WARNING!

Dangerous Voltage levels!

Any contact with energized parts of the product, may lead to an electrical shock which can lead to serious injuries or even death!

- Consider all regulations for electrical installations.
- The system must be disconnected from any power supply during maintenance work.
- Any electrical work on the system is only allowed by authorized qualified personal.



ATTENTION!

Permitted operating parameters!

Observe the permitted operating parameters, any operation exceeding this parameters can lead to malfunctions and may lead to damage on the instrument or the system.

- Do not exceed the permitted operating parameters.
- Make sure the product is operated in its permitted limitations.
- Do not exceed or undercut the permitted storage and operation temperature.
- The product should be maintained frequently, at least annually.

General safety instructions

- It is not allowed to use the product in explosive areas.
- Please observe the national regulations before/during installation and operation.

Remarks

- It is not allowed to disassemble the product.



ATTENTION!

Measurement values can be affected by malfunction!
The product must be installed properly and frequently maintained, otherwise it may lead to wrong measurement values, which can lead to wrong results.

Storage and transportation

- Make sure that the transportation temperature of device is between -30 ... +70 °C.
- For transportation it is recommended to use the packaging which comes with the device.
- Please make sure that the storage temperature of the device is between -40 ... +85 °C.
- Avoid direct UV and solar radiation during storage.
- For the storage the humidity has to be <90%, no condensation.

2 Registered trademarks

SUTO®

Registered trademark of SUTO iTEC

MODBUS®

Registered trademark of the Modbus Organization, Hopkinton, USA

3 Application

The Power and Energy Meter is designed to measure the actual power consumption in kW and accumulates the energy consumption in kWh of a 3-phase load. Additionally other measured parameters such as current, voltage, cos phi etc. are available as well.

4 Features

- Measures active and reactive power, frequency, voltage, currents, power factor.
- Accumulates active energy [kWh].
- 3 phase 3 wire, 3 phase 4 wire, 1 phase 2 wire measurement
- Modbus / RTU output to S551.

5 Technical data

5.1 General

CE	
Parameters (rms values)	Voltage of each phase and average voltage [V] Current of each phase and average current [A] Active Power [kW] Reactive Power [kvar] Apparent Power [kVA] Energy (per phase and summary) Power factors Frequency [Hz]
Measuring range	Nominal voltage: 100 ... 500 VAC
	Power: up to 2500 kW (depends on Rogowski coil)
Frequency range	50 / 60 Hz
Sampling rate	8 k/sec
Connection	M12 connector
Available clamp sensors	Rogowski coil 1 ... 100 A 10 ... 1000 A 30 ... 3000 A

Operating temperature	-25 ... +55°C
Storage temperature	-40 ... +85°C
Protection class	IP 20
Dimensions	177 mm x 60 mm x 203 mm (L X W X H)
Weight	800 g

5.2 Electrical data

Power supply	24 VDC, 2 W
Current consumption	Max. 100 mA

5.3 Input-signals

Rogowski Coil	0 mV ... 333 mV
---------------	-----------------

5.4 Accuracy

Voltage	0.2 % (100 ... 500 V)
Current	0.5 % (1% ... 120% of rang)
Power Factor	0.005 from 10 ... 120 %
Frequency	0.01 % from 45 ... 65 Hz
Active/Apparent Power	IEC62053-22 Class 0.5
Reactive Power	IEC62053-21 Class 2
Active Energy	IEC62053-22 Class 0.5 s
Reactive Energy	IEC62053-21 Class 2

6 Dimensional drawing (in mm)

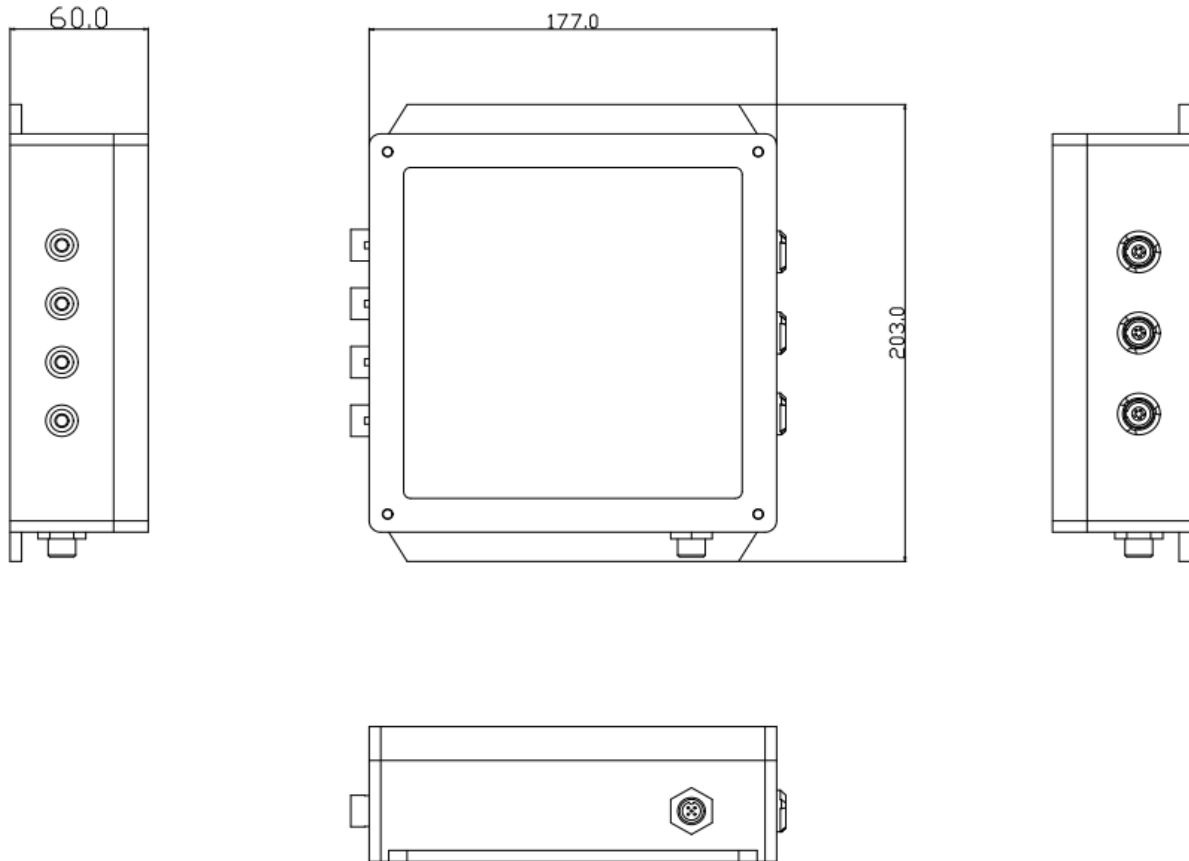

7 Installation

Please make sure that all components listed below are included in your package.

Qty	Description	Item No.
1	S110-P Power and Energy Meter	P554 0134
3	Rogowski coils	1000A = S554 0160 3000A = S554 0161 100A = S554 0162
4	Test leads	No P/N
4	Test clips	No P/N
1	5 m cable with connector to S551.	A553 0111
1	Instruction manual	No P/N

7.1 Voltage and current connection

7.1.1 3-phase / 4-wire connection

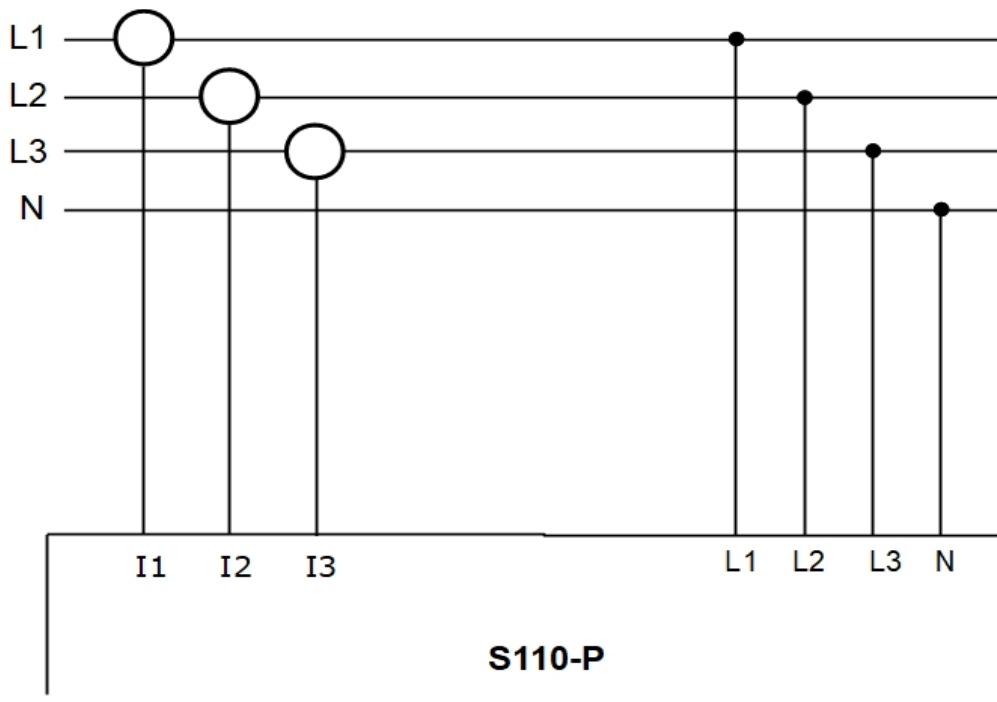

7.1.2 3-phase / 3-wire connection

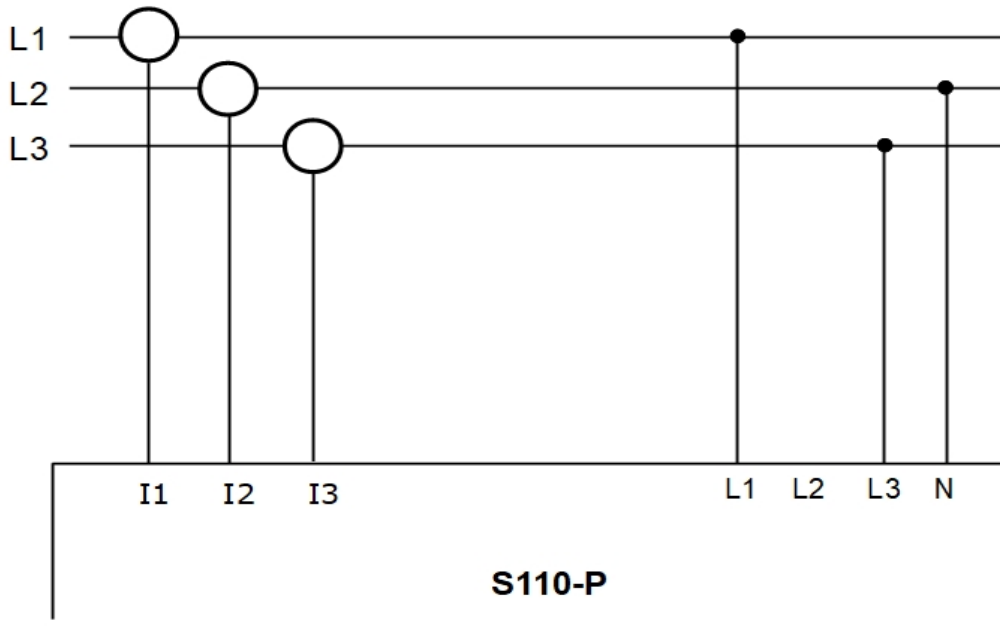

7.1.3 1-phase / 2-wire connection

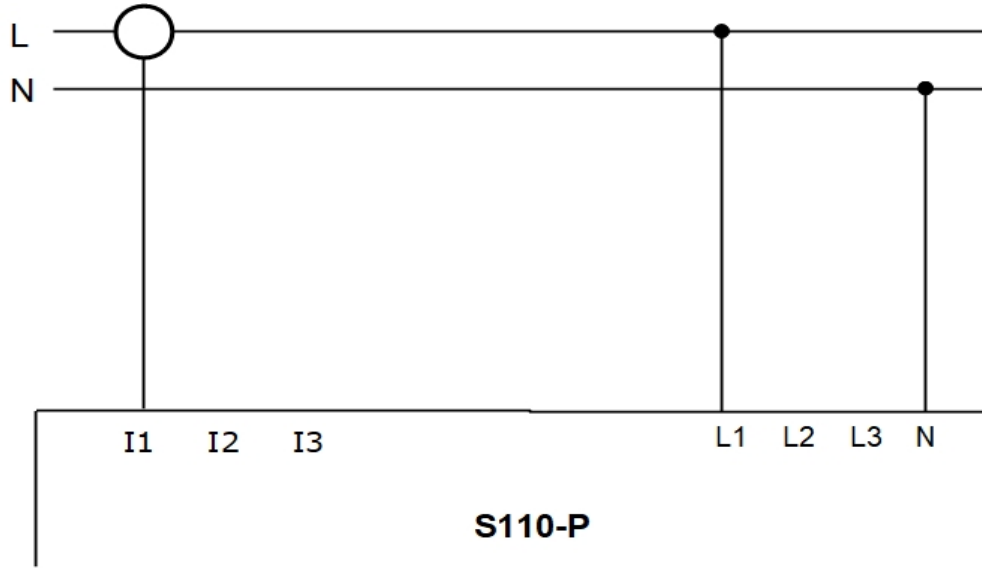

7.2 Electrical connection

The S110-P is connected to the portable data logger S551. For the electrical installation please observe the following instructions.

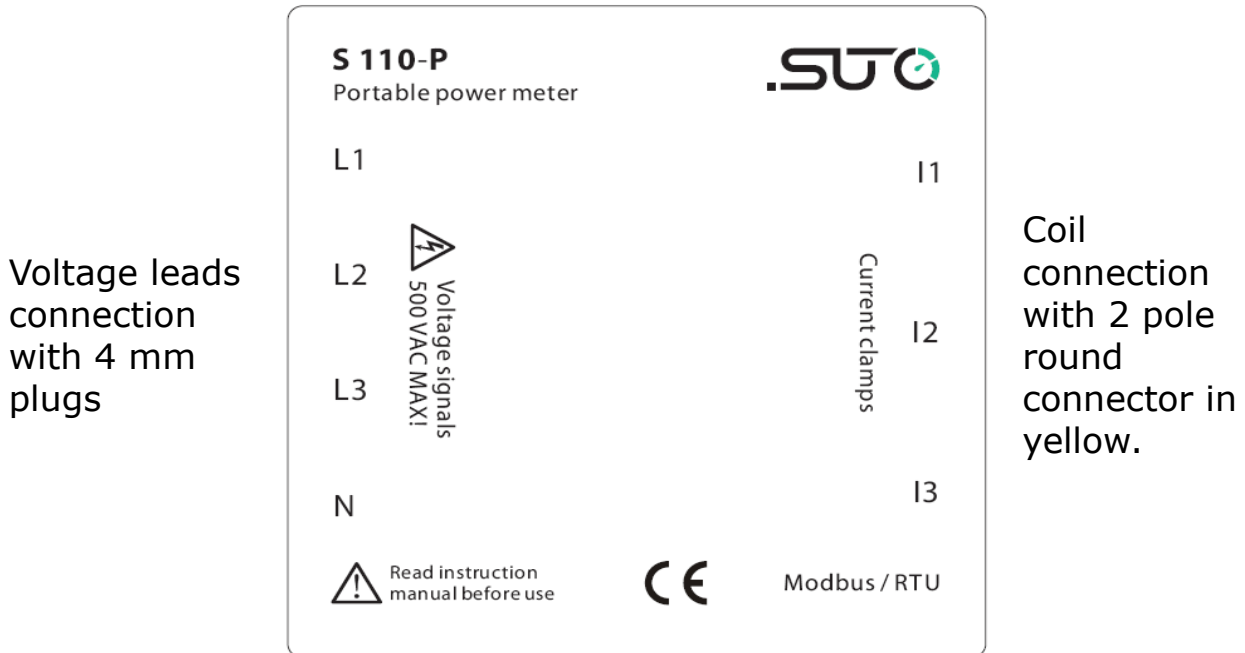

Connection to S551 via Modbus / RTU.

7.2.1 Connection to S551

1. Connect the S110-P with the S551 via Modbus port.
2. Power on S551 and then the S110-P will be detected automatically.
3. Press the **Menu** button on the interface of S551 and select the sensor type of clamp current sensor. For this please have a look at the picture below.
4. Press Save when you have changed the settings.
5. go back to "Home"

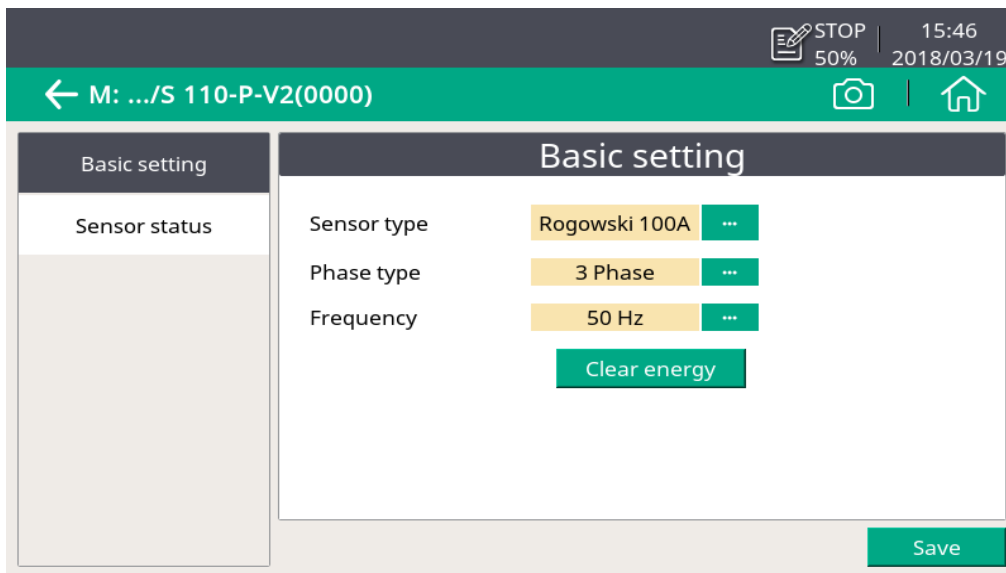
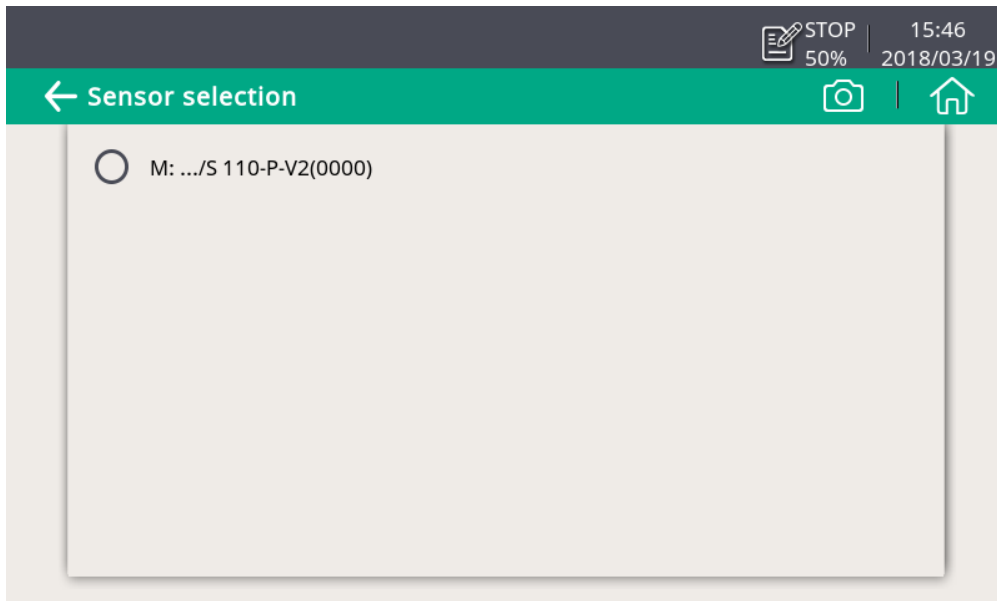

6. By pressing the **Value** button the online view will be shown. Use the arrows to see all windows.

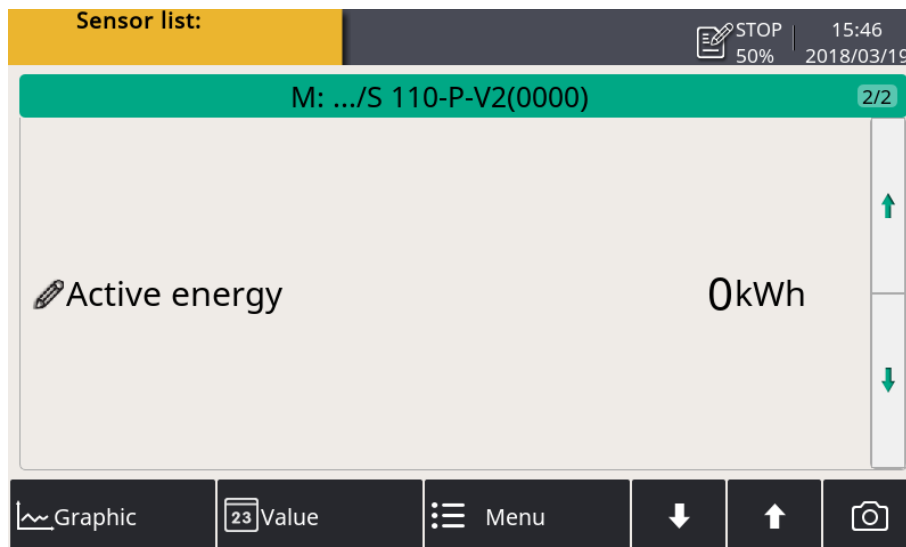
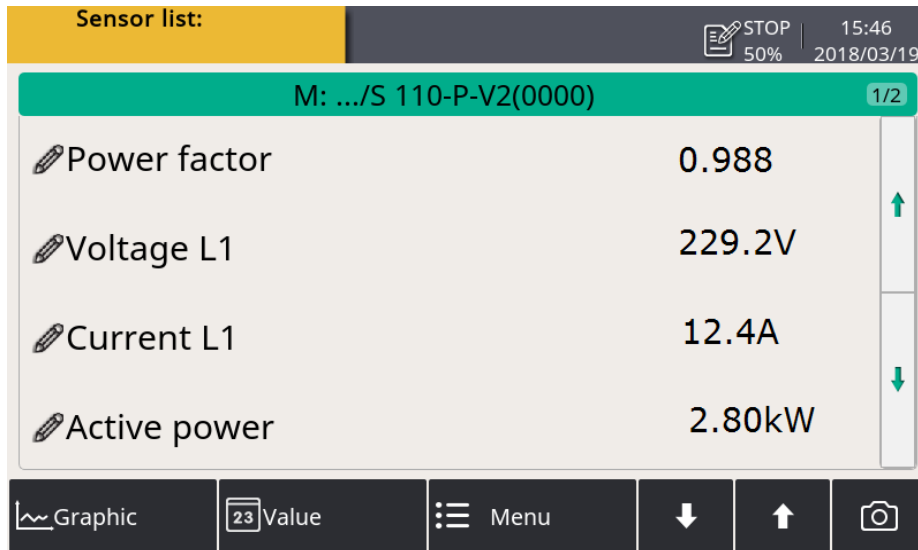

7.2.2 Connection to the Rogowski coils

Please observe the following steps to connect the coils.

1. Place the coil's around the isolated conductor.
2. Take care of current orientation, There is an arrow on body to indicate direction.

Coils for S110-P:

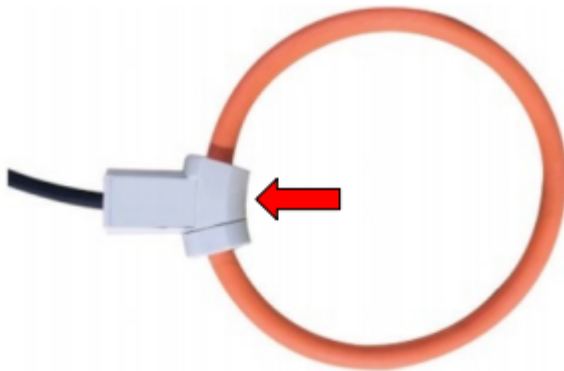

Arrow indication on the grey plastics for the current direction!

Typical connection for the S110-P:

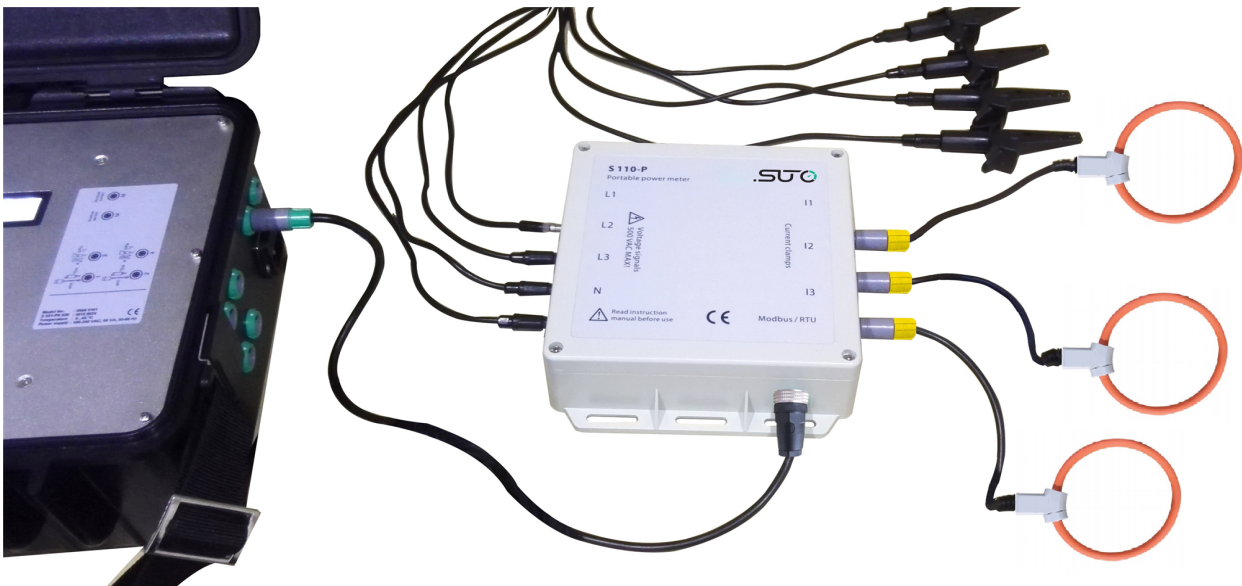

7.2.3 Connection to the Voltage leads

For S110-P connect the voltage leads (L1, L2, L3 and N) to the 3 phase conductors. Connect N if a 4-wire connection is required.

8 Optional extra accessories

For the particular type the following extra accessories are available:

- Transport case S551 for sensors and cables.

8.1 Extra accessories for S110-P

- Rogowski coil, 1000 A, 100 mm diameter, 1.8 m cable, connector to S110-P.
- Rogowski coil, 3000 A, 150 mm diameter, 1.8 m cable, connector to S110-P.
- Rogowski coil, 100 A, 16 mm diameter, 1.8 m cable, connector to S110-P.

9 Maintenance

To clean the power meter it is recommended to use moist cloth only.



ATTENTION!

Do not use isopropyl alcohol to clean the power meter!

10 Disposal or waste



Electronic devices are recyclable material and do not belong in the household waste.

The sensor, the accessories and its packings must be disposed according to your local statutory requirements.

The dispose can also be carried by the manufacturer of the product, for this please contact the manufacturer.

SUTO iTEC GmbH

Grißheimer Weg 21
D-79423 Heitersheim
Germany

Tel: +49 (0) 7634 50488 00
Email: sales@suto-itec.com
Website: www.suto-itec.com

SUTO iTEC (ASIA) Co., Ltd.

Room 10, 6/F, Block B, Cambridge Plaza
188 San Wan Road, Sheung Shui, N.T.
Hong Kong

Tel: +852 2328 9782
Email: sales.asia@suto-itec.com
Website: www.suto-itec.com

UTO iTEC Inc.

5460 33rd St SE
Grand Rapids, MI 49512
USA

Tel: +1 (616) 800-7886
Email: sales.us@suto-itec.com
Website: www.suto-itec.com

All rights reserved ©

Modifications and errors reserved

S110-P-V2_im_en_V2024-1